

INSTRUCTION MANUAL

BS-2 Dividing Head - Universal 132.7mm



D003



OPERATION INSTRUCTIONS

Semi-Universal Dividing Head BS - 0 & BS - 1 Type

These heads are suitable for milling grinding and drilling work. A plain dividing plate with 24 notches gives direct divisions of 2, 3, 4, 6, 8, 12 and 24. By indirect indexing (worm gear ratio 1:40) all divisions up to 50 and many above 50 can be carried out (see indexing chart). Divisions beyond the indirect indexing range are obtained by using the differential system which gives all divisions up to 1000. The indexing chart supplied with each head lists all divisions up to 380. Spiral milling work can also be carried out with BS-2 dividing heads.

Construction: These attachments combine rigidity with accuracy. The indexing spindle runs in precision taper roller bearings virtually free of play. In contrast to conventional designs the direct indexing plate is mounted at the tapered front indexing spindle. Dividing head and indexing spindle can be swivelled from horizontal to vertical. Indexing spindle, worm, direct indexing pin are hardened and ground, as well as centers and indirect indexing pin. The wormwheel is made of a special hard phosphor-bronze. Worm and wormwheel as well as most of the other revolving parts rotate in oil.

ENCLOSURE :

1. Fixed tailstock
2. Carrier
3. Center for head and tailstock
4. Direct indexing plate with 24 notches
5. Indirect indexing plate with 18 circles of holes 15-49.
 - A 15, 16, 17, 18, 19, 20
 - B 21, 23, 27, 29, 31, 33
 - C 37, 39, 41, 43, 47, 49
6. 12 change gears for differential and spiral milling. (only BS-2)
7. Change gear quadrant and 2 bolts (only BS-2)
8. Flange plate,
9. Test certificate
10. Operating instructions
11. Indirect dividing table
12. Differential dividing table . (only fitting BS-2)
13. Table for spiral milling (only fitting BS-2)

Thread Spindle: BS-0.1. 1 1/2 - 8TPI

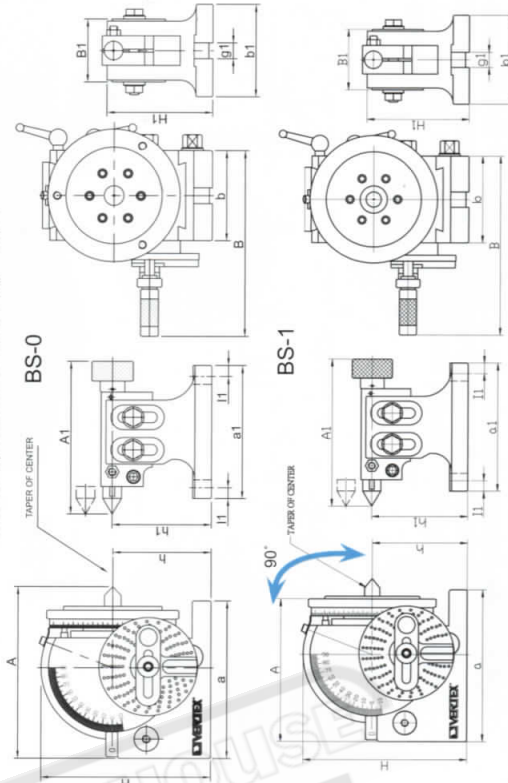
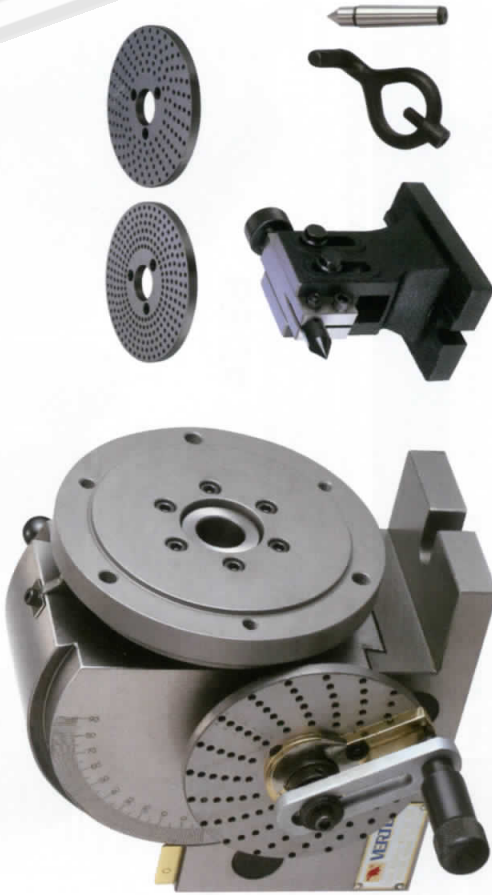

BS-0,1 (Head-stock):

BS-0,1 (Tail-Stock):

ORDER NO.	A	B	H	I	a	b	g	h	TAPER OF CENTER	SPINDLE THROUGH HOLE	CODE NO.
BS-0	177	188	173	13	160	91	16	100	MT-2	18	1001-050
BS-1	245	230	220	19	205	114	16	128	MT-3	20	1001-051

ORDER NO.	A1	B1	H1	I1	a1	b1	h1	g1	N.W. (KG)
BS-0	155-180	64	107	11	134	94	80-108	16	4
BS-1	170-195	64	150	11	155	110	150-115	16	5.3

Unit:mm

Unit:mm



Universal Dividing Head BS - 2 & BS - 2A Type



BS-2

STANDARD ACCESSORIES :

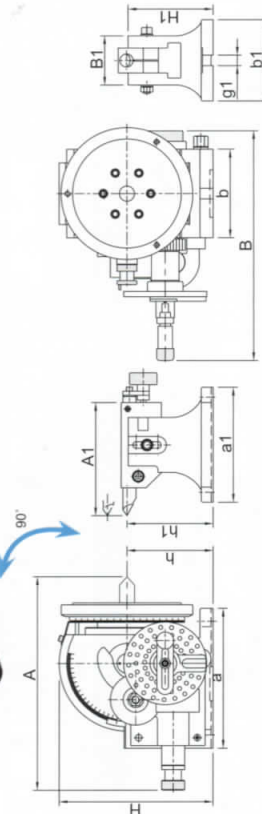
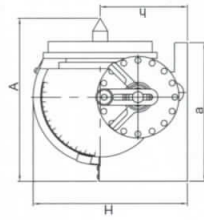

BS-2A

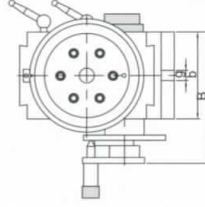
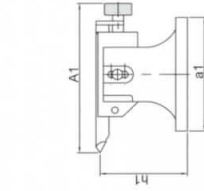

BS-2, 2A (Head-stock)

ORDER NO.	A	B	H	I	a	b	g	h	Taper of center	SPINDLE THROUGH HOLE	CODE NO.
BS-2	359	340	235	20	212	135	16	134	MT-4	25	1001-052
BS-2A	285	202	237	20	213	134	16	134	MT-4	25	1001-057

Unit:mm

BS-2, 2A (Tail-stock)

ORDER NO.	A1	B1	H1	I1	a1	b1	h1	g1	N.W. (KG)
BS-2	135-175	75	130	15	175	125	120-145	16	10
BS-2A	218	74	139	15	175	124	134	16	10

Operation
The indexing attachment is a precision instrument and should, therefore, be handled with care. After unpacking, remove anti-rust compound. Before setting up the head on the machine table, both the table surface and the base of the dividing head must be free of dirt and chips in order to obtain maximum accuracy.

Maintenance
A continuous maintenance i.e. lubrication is necessary. Special care should be taken in direct indexing operations, that the holes of the direct indexing plate and the direct dividing index are absolutely clean, as even a slight contamination of these parts results in indexing faults. Just two lubrication point has to be oiled.

Adjustment of worm backlash

Any backlash between worm and worm wheel encountered after extensive operation is removed as follows:

1. Loosen locking bolt and turn the stop screw so far until worm backlash has been taken out. In this respect however, a free turning of the hand crank should still be possible.
2. Tighten locking bolt.

The worm backlash has been removed when no more play can be observed on the index head spindle.

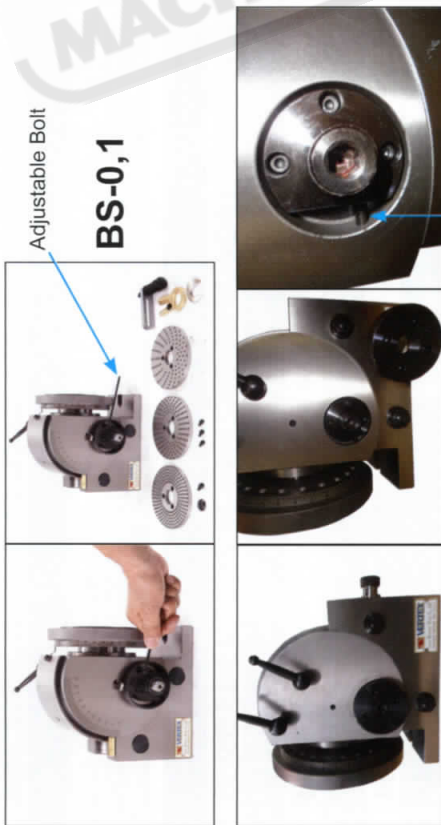

Direct indexing

Swivel out the worm. For further indexing, loosen the spindle locking and lift out the direct dividing index with the respective lever. The indexing spindle can then be turned by the desired number of holes, after which the direct dividing index is engaged again. In the case of relatively heavy work tighten the spindle locking as well. The standard equipment includes a holes plate with 24 holes.

Rule: Divide 24 by the number of divisions required and the result equals the number of holes to move in the 24-hole rapid indexplate. Thus, number of holes to move = $24/D$, where D is the number of divisions.

Indirect indexing

In this case swivel the worm carefully to the stop by means of the swivel lever, at the same time turning slightly the indexing spindle and then the hand crank. Disengage the direct dividing index. Operate clamping device for hole plate.

Then take the following steps:

1. Look up circle of holes in the indexing table. If the particular circle of holes is not visible on the index plate, remove hand crank and indicator bracket, remove index plate after loosening of holding screws and screw it on again in reversed form. (The circles of holes stated are distributed over both sides of the index plate).
2. Adjust indicator bracket after loosening of locking screw in such a way that the number of holes which is also shown in the table remains uncovered between the legs.
3. Tighten locking screw
4. After loosening of central nut shift hand crank in such a way that the index pin can engage in a hole of the desired circle of holes. Do not disalign hand crank! After tightening the central nut, it must be possible to engage the index of the hand crank in every desired hole of the circle.
5. Then engage the index of the hand crank in the starting position and turn the indicator bracket in indexing direction until the index lies flush to the inside of the second indicator leg. (Note: if + is shown behind the number of holes in the table, move the indicator bracket in the direction opposite to indexing until it contacts the index).
6. For further division disengage the index, turn the hand crank until the index can engage in the last hole before the second indicator leg.
7. If, by accident, the index has passed over the intended hole, the handle has to be turned back for several holes in order to engage the index in the right hole by turning the handle again in clockwise direction.
8. Clamp the indexing spindle for heavy work.

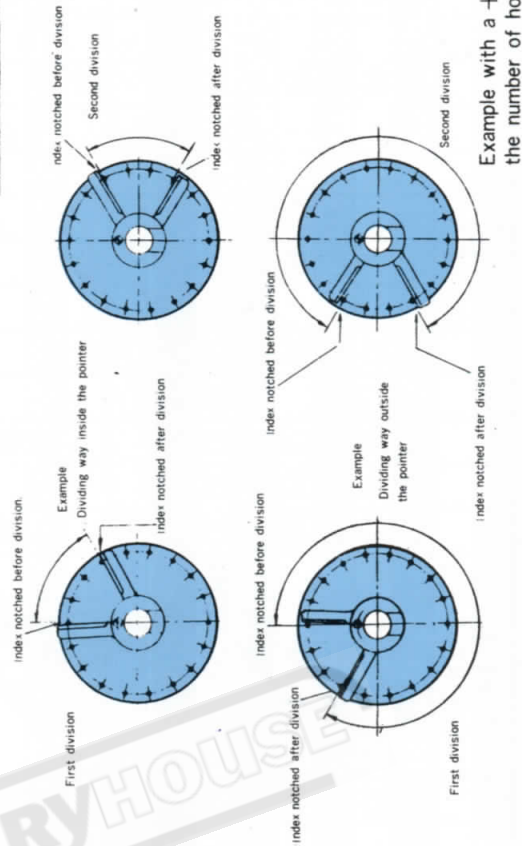
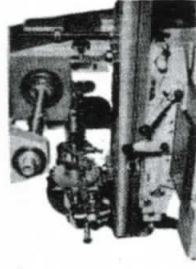

Example: Divisions $D = 9$. Then $T = 40/9$, or 4 turns plus $4/9$ turn. Multi-ply the fraction by a suitable number, say 2. Then $4/9$ becomes $8/18$. Since you have an 18-hole circle, you will index 4 turns plus 8 spaces on the 18-hole circle.

Differential indexing

This process is employed for all index numbers which cannot be obtained by indirect indexing in this case clamp the differential bolt into the rear end of the indexing spindle and loosen the locking pin for the index plate. Then attach the change gears as per indexing table on the bracket or the differential bolt and engage them with a minimum of slack. Then carry out the indexing process in exactly the same manner as described for indirect indexing.

DIVIDING TABLE (WORM RATIO 1:40) T : Desired dividural number H : Hole number of the index plate N : Number of revolution of the crank handle N = 40 / T :

T	1	2	3	4	5	6	7	8	9	10	11	12	13	14	15	16	17	18	19	20	21	22	23	24	25
H	*	33	*	*	33	49	*	18	*	33	39	39	49	33	20	17	18	19	*	21	33	23	33	33	20
N	20	$13\frac{11}{33}$	10	8	$6\frac{22}{33}$	$5\frac{35}{49}$	5	$4\frac{8}{18}$	4	$3\frac{21}{33}$	$3\frac{11}{33}$	$3\frac{3}{39}$	$2\frac{42}{49}$	$2\frac{22}{33}$	$2\frac{10}{20}$	$2\frac{6}{17}$	$2\frac{4}{18}$	$2\frac{2}{19}$	2	$1\frac{19}{21}$	$1\frac{27}{33}$	$1\frac{17}{23}$	$1\frac{22}{33}$	$1\frac{12}{20}$	

T	26	27	28	29	30	31	32	33	34	35	36	37	38	39	40	41	42	43	44	45	46	47	48	49	50
H	39	27	49	29	33	31	20	33	17	49	18	37	19	39	*	41	21	43	33	18	23	47	18	49	20
N	$1\frac{21}{39}$	$1\frac{13}{27}$	$1\frac{21}{49}$	$1\frac{11}{29}$	$1\frac{11}{33}$	$1\frac{9}{31}$	$1\frac{5}{20}$	$1\frac{7}{33}$	$1\frac{3}{17}$	$1\frac{7}{49}$	$1\frac{2}{18}$	$1\frac{3}{57}$	$1\frac{1}{19}$	$1\frac{1}{39}$	1	$\frac{40}{41}$	$\frac{20}{21}$	$\frac{40}{43}$	$\frac{30}{53}$	$\frac{16}{18}$	$\frac{20}{23}$	$\frac{40}{47}$	$\frac{15}{18}$	$\frac{40}{49}$	$\frac{16}{20}$

T	51	52	53	54	55	56	57	58	59	60	61	62	63	64	65	66	67	68	69	70	71	72	73	74	75	76	77	78	79	80	81	82	83	84	85	86	87	88	89	90
H	33	39	33	27	33	49	33	29	33	33	16	31	16	16	39	33	49	17	49	49	15	18	15	37	15	19	20	39	20	20	21	41	21	21	17	43	33	33	18	18
N	$\frac{24}{33}$	$\frac{30}{39}$	$\frac{20}{33}$	$\frac{24}{33}$	$\frac{35}{49}$	$\frac{22}{33}$	$\frac{20}{29}$	$\frac{22}{33}$	$\frac{20}{33}$	$\frac{10}{16}$	$\frac{10}{16}$	$\frac{20}{31}$	$\frac{10}{16}$	$\frac{10}{16}$	$\frac{24}{39}$	$\frac{20}{33}$	$\frac{28}{49}$	$\frac{10}{17}$	$\frac{28}{49}$	$\frac{28}{49}$	$\frac{8}{15}$	$\frac{10}{18}$	$\frac{8}{15}$	$\frac{20}{37}$	$\frac{8}{15}$	$\frac{10}{19}$	$\frac{10}{20}$	$\frac{20}{39}$	$\frac{10}{20}$	$\frac{10}{20}$	$\frac{10}{21}$	$\frac{10}{21}$	$\frac{10}{21}$	$\frac{8}{17}$	$\frac{15}{43}$	$\frac{15}{33}$	$\frac{8}{18}$	$\frac{8}{18}$		
A	64	64	48	48	32	72	40	48	48	48	48	64	64	64	64	64	64	48	32	32	64	40	48	48	48	48	48	48	48	48	48	48	48	48	48	48	48	48	48	
B	44	44	24	24	48	48	48	48	48	48	48	48	48	48	48	48	48	28	56	32	32	40	48	48	48	48	48	48	48	48	48	48	48	48	48	48	48	48	48	48
C	48	48	40	40	40	40	40	40	40	40	40	40	40	40	40	40	40	40	40	40	40	40	40	40	40	40	40	40	40	40	40	40	40	40	40	40	40	40	40	
D	24	24	40	40	40	40	40	40	40	40	40	40	40	40	40	40	40	40	40	40	40	40	40	40	40	40	40	40	40	40	40	40	40	40	40	40	40	40	40	
E			28	40	40	40	40	40	40	40	40	40	40	40	40	40	40	40	40	40	40	40	40	40	40	40	40	40	40	40	40	40	40	40	40	40	40	40	40	
F																																								

T	91	92	93	94	95	96	97	98	99	100	101	102	103	104	105	106	107	108	109	110	111	112	113	114	115	116	117	118	119	120	121	122	123	124	125	126	127	128	129	130
H	20	23	20	47	19	20	20	49	20	20	33	33	33	39	21	33	33	27	33	33	33	33	33	33	33	33	33	33	33	33	33	33	33	33	33	33	33	33	33	33
N	$\frac{8}{20}$	$\frac{10}{23}$	$\frac{8}{20}$	$\frac{20}{47}$	$\frac{8}{19}$	$\frac{8}{20}$	$\frac{8}{20}$	$\frac{20}{49}$	$\frac{8}{20}$	$\frac{8}{20}$	$\frac{12}{33}$	$\frac{12}{33}$	$\frac{12}{33}$	$\frac{15}{39}$	$\frac{8}{21}$	$\frac{12}{33}$	$\frac{12}{33}$	$\frac{10}{27}$	$\frac{12}{33}$	$\frac{12}{33}$	$\frac{12}{33}$	$\frac{12}{33}$	$\frac{11}{33}$	$\frac{11}{33}$	$\frac{11}{33}$	$\frac{10}{29}$	$\frac{11}{33}$	$\frac{11}{33}$	$\frac{11}{33}$	$\frac{10}{33}$	$\frac{5}{16}$	$\frac{10}{33}$	$\frac{10}{33}$	$\frac{5}{31}$	$\frac{5}{16}$	$\frac{5}{16}$	$\frac{10}{33}$	$\frac{12}{39}$		
A	72	56	64	48	64	48	24	72	64	56	64	48	64	48	48	48	48	48	48	48	48	48	48	48	48	48	48	48	48	48	48	48	48	48	48	48	48	48	48	
B	40	40	40	40	40	40	40	40	40	40	40	40	40	40	40	40	40	40	40	40	40	40	40	40	40	40	40	40	40	40	40	40	40	40	40	40	40	40	40	
C	48	48	48	48	48	48	48	48	48	48	48	48	48	48	48	48	48	48	48	48	48	48	48	48	48	48	48	48	48	48	48	48	48	48	48	48	48	48	48	
D	24	24	24	24	24	24	24	24	24	24	24	24	24	24	24	24	24	24	24	24	24	24	24	24	24	24	24	24	24	24	24	24	24	24	24	24	24	24	24	
E			28	32																																				
F																																								

No.296, Sec.1, Feng Shih Road, Feng Yuan, Taichung Hsien, Taiwan
 TEL: 886-4-25237596/25237621~22 FAX: 886-4-25234823/25205905
 E-mail: vertex.huang@msa.hinet.net / vertex.co@msa.hinet.net http://www.vertex-tw.com.tw/products



SINCE 1978